



R51 PATHFINDER

Nissan

















Installation Instructions



R51 Pathfinder Emuwing Installation Instructions

Due to the intrusion of the hinge this product is not suitable for vehicles with passengers in the seats adjacent to the Emuwing. The Emuwing is designed as **an addition** to a storage system and should be removed if the seats adjacent to the Emuwing are ever reinstated.

Parts List

| | | |
|---|---|--|
|  <p>Emuwing Frame - One per side</p> |  <p>Emuwing Panel - One per side</p> |  <p>Polyurethane Glue & nozzle - One (1) per kit</p> |
|  <p>Support brackets - Two (2) per side</p> |  <p>Hinge and Faceplate - Two (2) per side</p> |  <p>Adhesive Weatherstrip - One (1) length per side</p> |
|  <p>Pinchweld (if applicable) - One (1) length per side</p> |  <p>Gas Struts - Two (2) per side</p> |  <p>3M Primer - One (1) per side</p> |
|  <p>M5 CSK bolts, Washer & Nyloc nut - Four (4) per side attached to frame</p> |  <p>Panhead bolts - Four (4) per side</p> |  <p>M4 Hex bolts, Washer & Nyloc nut - Eight (8) per side</p> |
|  <p>Handle Two (2) per side</p> |  <p>Keys & Keyring - One (1) keyring with two (2) keys for each Emuwing</p> |  <p>Chalk Pen One (1) per kit</p> |
| <p>Tools required:</p> <ul style="list-style-type: none"> • 4mm Allen Key • Medium size Phillips's head screwdriver • Eight to Twelve Clamps per side • Spanners 7mm, 8mm and *27mm • Sockets 7mm and 10mm • Caulking/Glue gun <p>*Glass kits only</p> | | <p>Other things that may be useful:</p> <ul style="list-style-type: none"> • Wax and Grease remover • Clean rags or kitchen paper • Masking tape • Heat Gun • Trim pry's for interior panels if applicable |

R51 Pathfinder Emuwing Installation Instructions

Due to the intrusion of the hinge this product is not suitable for vehicles with passengers in the seats adjacent to the Emuwing. The Emuwing is designed as **an addition** to a storage system and should be removed if the seats adjacent to the Emuwing are ever reinstated.

Contents

This installation is one of our most complex and time consuming, this should only be undertaken by those with significant DIY experience. 3

1: Remove the existing rear window 3

- Remove interior trim, glass and rubber 3

2: Installing the frame. 3

- Positioning the frame. 3

- Gluing the frame into place. 4

3: Attaching the door panel. 5

- Attach the hinges. 5

- Placing the door panel. 5

- Securing the door panel 5

- Attach the gas struts. 6

4: Fitting the weatherstrip, foam rubber and adjusting the door panel depth. 6

- Attaching the strikers 6

- Applying the weather-strip and foam rubber 6

- Applying the weather-strip. 6

- Primer 6

- Panel adjustments – left/right and up and down 6

- Panel adjustments – Depth 7

The following instructions detail the installation of your new EmuWing kit.

Allow a total of one to two hours fitting time for each panel, excluding curing time.

Read the instructions thoroughly before starting the installation.

Allow any additional time that may be required for rust repairs.

We have installations on our YouTube channel which you may wish to watch before commencing.

As this is a DIY kit. Please ensure you read the instructions carefully before beginning installation as once installed, no claims can be made due to incorrect installation.

R51 Pathfinder Emuwing Installation Instructions

Due to the intrusion of the hinge this product is not suitable for vehicles with passengers in the seats adjacent to the Emuwing. The Emuwing is designed as **an addition** to a storage system and should be removed if the seats adjacent to the Emuwing are ever reinstated.

This installation is one of our most complex and time consuming, this should only be undertaken by those with significant DIY experience.

The Emuwing and the rear door of the Pathfinder will interfere, only one should be opened at any one time – this is due to the shape requirement of the door panel on this vehicle.

1: Remove the existing rear window

- Remove interior trim, glass and rubber.

Cargo barriers may make removal of the interior trim difficult and may need to be moved or removed completely.

Completely remove the interior trim surrounding the window, this is held in place by plastic clips that may have become brittle over time.

The window can now be removed. We recommend contacting a glazier to have the window removed as the panel is glued firmly in place. If you do decide to remove the windows yourself – beware as there are plastic clips within the existing glue that are difficult to cut through. Take extra care not to damage any paintwork as this will be visible once the installation is complete. After removing the window, wash off any dirt and carefully remove as much residual glue from the bodywork as you can.

The glue does not have to be completely removed however as it is visible it should be removed for aesthetic purposes – silicone removal scrapers are available from most hardware stores; these require significant perseverance and elbow grease due to the amount of glue being removed. We have also found wax and grease remover will help to dissolve the last stubborn remnants. Expect this to take two to four hours per window.

2: Installing the frame.

- Positioning the frame.

Make sure you understand the positioning of the frame before attempting to glue it into position. This is critical so the panel aligns to the hinges later in the assembly.

The frame mounts internally on this vehicle and should, if properly placed cover the interior trim – and the support brackets at the top should sit just below the top line of the interior trim



R51 Pathfinder Emuwing Installation Instructions

Due to the intrusion of the hinge this product is not suitable for vehicles with passengers in the seats adjacent to the Emuwing. The Emuwing is designed as **an addition** to a storage system and should be removed if the seats adjacent to the Emuwing are ever reinstated.

- Gluing the frame into place.

The surface of the car body and the frame should be clean, dry, and free from all traces of grease, oil, and dust before applying a bead of Sikaflex around the inside of the car body, (*paying particular attention*) to the corners increasing the bead enough to fill any higher spots between the body and the frame. Apply a continuous thick enough to ensure good adhesion, considering the high and low surfaces the frame will be glued too.

Make sure there are no gaps in the bead, and it is applied evenly. Get some light clamps and place them close by, you will need them as you place the frame into position.

Once the glue is applied and the frame is in place, apply the clamps paying particular attention to the corners and leave to dry for at least 24 hours. Using a torch check no light can be seen between the frame and the car body.

Whilst the glue is wet and the frame is clamped, carefully clean up any excess glue from around the frame.

Once the glue is applied and the frame is in place, leave to dry for at ***least 24 hours***.

The glue can be cleaned up using wax and grease remover whilst wet, do not leave it to dry or it will be difficult to remove without damage to the paintwork.

Do Not proceed with fitting any hardware to the frame until the glue has set and the frame is securely in place (at least 24 hours). Figure 3.

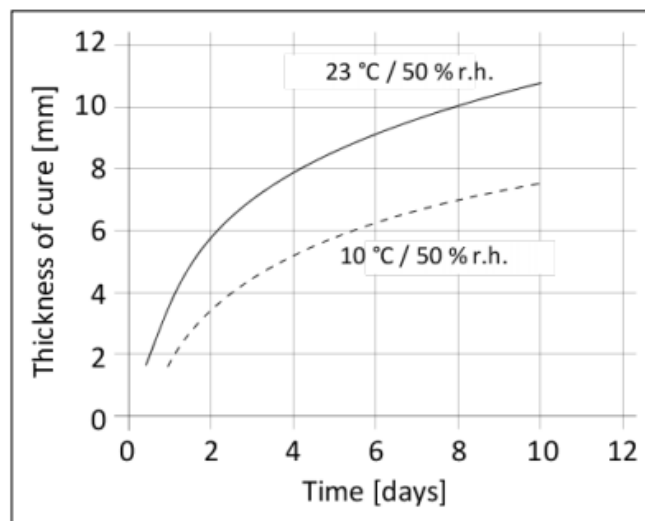

Figure 3.

R51 Pathfinder Emuwing Installation Instructions

Due to the intrusion of the hinge this product is not suitable for vehicles with passengers in the seats adjacent to the Emuwing. The Emuwing is designed as **an addition** to a storage system and should be removed if the seats adjacent to the Emuwing are ever reinstated.

3: Attaching the door panel.

Figure 6.

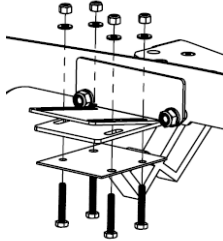

- Attach the hinges.

Attach the Hinges to the frame using the supplied 4mm nuts, bolts and washers so the face plate protrudes around 8mm from the frame. The exact depth will be adjusted later. Figure 6.

- Placing the door panel.

When the hinges are in the closed position, place the door panel centrally. We suggest using a spacer at the bottom of the door panel to lift it up slightly so that the panel is aligned correctly. Figure 9.

Note: when the gas struts are attached the door panel will be pushed up as the hinges compress – try to allow for this when placing the door by positioning the panel 1 or 2 mm lower than it needs to be.

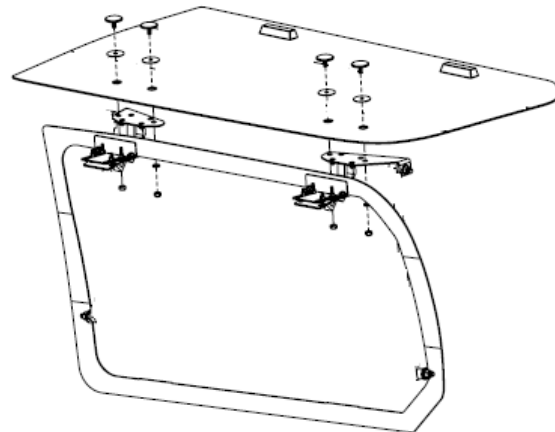

Figure 9.

Close the handles a little so the cam latches over the frame to secure the panel in place while fixing into position.

A gap should be left at the top of the door panel of around 5mm, this ensures there is no interference when opening and closing the panel.

- Securing the door panel.

Placing the Pan Head bolts from the outside; fit a washer and nut on the inside.

Once all four pan heads are in place and secure, check that the door does not foul the car when opening and closing. If there is any fouling, adjust the door accordingly before attaching the gas struts.

Before loosening any nuts for any further adjustments, detach the gas struts first to prevent the hinges from twisting.

R51 Pathfinder Emuwing Installation Instructions

Due to the intrusion of the hinge this product is not suitable for vehicles with passengers in the seats adjacent to the Emuwing. The Emuwing is designed as **an addition** to a storage system and should be removed if the seats adjacent to the Emuwing are ever reinstated.

- Attach the gas struts.

Once the Door panel is adjusted as much as possible open the door and attach the struts (wider end to the top). Close the panel carefully, again watching if it touches the car as it closes. Once closed note any required adjustments to the door panel to align it with the car.

The depth of the door can be adjusted later, at this stage we are only concerned with the position of the panel in relation to the car however if your panel sits out from the frame more than 10mm it may be worth adjusting this in to at least 10mm.

4: Fitting the weatherstrip, foam rubber and adjusting the door panel depth.

- Attaching the strikers

The Stainless-steel strikers can now be glued in position so they align with the cams of the handles and prevent the frame being damaged when the handles are operated.

- Applying the weather-strip and foam rubber.

Place the foam rubber on the face of the frame that is visible from the outside of the car ensuring the support bracket bolts are covered to prevent any water ingress, the join should be at the bottom of the frame so start the application of the foam strip from the bottom middle. Be careful not to stretch the outside edge when applying around the corners, instead try to compress the inside edge.

- Applying the weather-strip.

Close the door panel and carefully mark inside the door panel around the inside edge of the frame noting the distance between the line and the edge of your frame.

- Primer

Before attaching the weather strip use the 3M primer where you will be applying the weather strip. Apply using long strokes exactly where the weather strip will be placed



Once the door has been marked and primed, the weather seal can be attached to the door following outside of the marked lines so the seal will line up on the frame (if the seal does not correctly align, moisture and dust will find its way into the back of the vehicle).



- Panel adjustments – left/right and up and down.

The door panel can be adjusted up/down and left/right by loosening the pan heads that attach the door to the hinge. Make note of the required adjustments and mark the current position of the hinge plate on the inside of the door before removing the struts and loosening the pan heads.

R51 Pathfinder Emuwing Installation Instructions

Due to the intrusion of the hinge this product is not suitable for vehicles with passengers in the seats adjacent to the Emuwing. The Emuwing is designed as **an addition** to a storage system and should be removed if the seats adjacent to the Emuwing are ever reinstated.

- Panel adjustments – Depth.

Close the door panel and check the depth to ensure it aligns with the car and compresses the weather seal. If adjustment is required loosen the hinges from the top supports (the gas struts do not need to be removed), apply pressure evenly to the outside of the door where the hinge meets the door until you see the rubber compress onto the frame, and then re-tighten the bolts.

Close the Emuwing ensuring neither seal has rolled and remains attached squarely to the frame and door panel, ensure the handles are closed and there is even pressure on the seal all the way around. Now use a heat gun to heat the door panel – this will activate the glue on the weather strip and affix it in place permanently. Be careful not to burn the seal directly. The panel should be heated to the point that it is very hot to the touch – above 50 degrees Celsius.

Leave the panel closed for an hour or two whilst the glue cools.

If additional help is required, please feel free to give us a call on +613 8592 1926 between the hours of 10am and 4pm AEST – Monday to Friday.

R51 Pathfinder Emuwing Installation Instructions

Due to the intrusion of the hinge this product is not suitable for vehicles with passengers in the seats adjacent to the Emuwing. The Emuwing is designed as **an addition** to a storage system and should be removed if the seats adjacent to the Emuwing are ever reinstated.

5: Glass supplement.

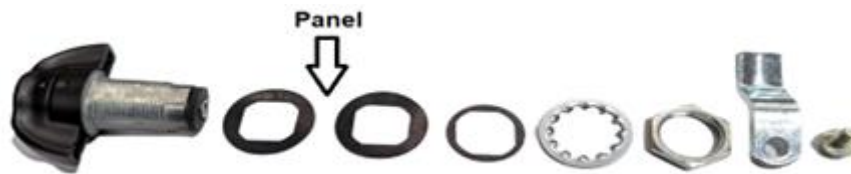

We recommend tinting the glass prior to installation, this ensures the weather strip will not deteriorate faster than usual due to UV exposure.

Instructions:

1. Ensure glass is tinted and dry before attempting assembly.
2. Disassemble handles noting the order of reassembly, the panel is located between the two rubbers when reassembling.
3. Tighten the barrel nut until the rubbers are compressed ensuring a good seal.
4. Assemble and insert handles.
5. Ensure thread locking compound is used on the 10mm bolt securing the cam latch.

Prior to installation of the Emuwing kit the handles should be reassembled into the glass panel.

Ensure thread locking compound is used on the threads of the 10mm bolt securing the Cam.

Website: emuwing.com.au

Phone: +61 3 9017 1614

Email: info@emuwing.com.au



For Distributor and Installer enquiries please email sales@emuwing.com.au

9/146 Northbourne Road
Campbellfield
Victoria, 3061

ABN: 84 617 251 733