



VANAGON T3

Volkswagen













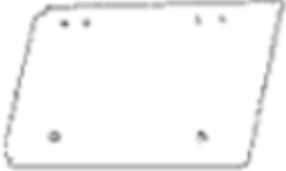



Installation Instructions



VW T3 Vanagon Emuwing Installation Instructions

Due to the intrusion of the hinge this product is not suitable for vehicles with passengers in the seats adjacent to the Emuwing. The Emuwing is designed as **an addition** to a storage system and should be removed if the seats adjacent to the Emuwing are ever reinstated.

Parts List

 <p>Frame 1 per side</p>	 <p>Wing Panel x 1 per side</p>	 <p>Glue and Nozzle x 1 per kit</p>
 <p>Support Brackets x 2 per side</p>	 <p>Hinge & Faceplate – One front & One rear per side (Pre-Assembled)</p>	 <p>Weather Seal, 1 per side cut to length</p>
 <p>Gas Struts – two per side</p>	 <p>Panhead bolts x 4 per side</p>	 <p>Pinch Weld, 1 per side cut to length</p>
 <p>M4 Nyloc Nut x 8 per side</p>	 <p>M4 Nyloc Washer x 8 per side</p>	 <p>M4 Hex Bolts x 8 per side</p>
 <p>Keyring x 1 per kit Keys x 2 per side</p>	 <p>Installation Instructions</p>  <p>Model specific installation instructions x 1 per kit</p>	 <p>Emuwing Flyer x 1 per kit</p>

Other items and Tools Required:

- Allen Key 3mm
- Medium size Phillips's head screwdriver
- Eight to Twelve Clamps per side
- Spanners and or sockets (7mm, 8mm, 10mm, *27mm)
- Caulking/Glue gun
- Wax and Grease remover or other solvent that leaves no residue
- Clean rags or kitchen paper
- Masking tape
- Heat Gun

*Glass models only

VW T3 Vanagon Emuwing Installation Instructions

Due to the intrusion of the hinge this product is not suitable for vehicles with passengers in the seats adjacent to the Emuwing. The Emuwing is designed as **an addition** to a storage system and should be removed if the seats adjacent to the Emuwing are ever reinstated.

Contents

Contents	2
1: Remove the existing rear window	3
Remove original window.	3
- Applying the pinch weld.	3
2: Installing the frame.	3
- Positioning the frame.	3
- Gluing the frame into place.	3
3: Attaching the door panel.	4
- Place and tighten the support brackets.....	4
- Attach the hinges.....	4
- Applying the weather-strip.....	5
- Primer	5
- Placing the door panel.....	5
- Securing the door panel.....	5
- Attach the gas struts.....	6
4: Adjusting the door panel depth.	6
- Adjustments – left/right and up and down.	6
- Adjustments – Depth.....	6
- Thread locking compound – handle/cam screws.	6
5: Glass supplement.	7

**The following instructions detail the installation of your new EmuWing kit.
Allow a total of one to two hours fitting time for each panel, excluding
curing time.**

**Read the instructions thoroughly before starting the installation.
Allow any additional time that may be required for rust repairs.
We have installations on our YouTube channel which you may wish to
watch before commencing.**

VW T3 Vanagon Emuwing Installation Instructions

Due to the intrusion of the hinge this product is not suitable for vehicles with passengers in the seats adjacent to the Emuwing. The Emuwing is designed as **an addition** to a storage system and should be removed if the seats adjacent to the Emuwing are ever reinstated.

As this is a DIY kit. Please ensure you read the instructions carefully before beginning installation as once installed, no claims can be made due to incorrect installation.

1: Remove the existing rear window

Remove original window.

Remove the existing rear window, start by getting one corner free – manipulate the rubber from the inside as you apply pressure, and with some perseverance it will start to come free. Once you have the corner out, move outside and continue to pull and it should come away. Be careful as it will suddenly come free, and you may drop/smash the glass or yourself.

- Applying the pinch weld.

After removing the rear window, wash off any dirt or residual glue from around the seam.

*If there is any rust address this now before continuing.

Apply the pinch weld supplied in the kit starting on the bottom edge, continue around the exposed seam ensuring that any interior trims and the roof lining are securely held in place.

2: Installing the frame.

- Positioning the frame.

Make sure you understand the positioning of the frame before attempting to glue it into position.

This is critical so the panel aligns to the hinges later in the assembly.

The frame mounts centrally with an even gap all the way around, if you do not get this perfect you will be able to adjust the door panel later during the installation.

Prior to applying any glue place the frame in position with a clamp on each corner, now apply masking tape around the position of the frame – this will help with the clean-up of any excess glue if any does squeeze out.

- Gluing the frame into place.

The surface of the pinch weld and the frame should be clean, dry, and free from all traces of grease, oil, and dust before applying a bead of Sikaflex around the outside of the pinch weld, (*paying particular attention*) to the corners, increasing the bead enough to fill any higher spots between the body and the frame. Apply a continuous bead around 5mm thick, increasing this to around 6 or 7mm around the corners.

Make sure there are no gaps in the bead, and it is applied evenly. Get some light clamps and place them close by, you will need them as you place the frame into position. The frame should be glued to the pinch weld – not the van!

Once the glue is applied and the frame is in place, apply the clamps paying particular attention to the corners and leave to dry for at least 24 hours. Using a torch check no light can be seen between the frame and the van body.

Whilst the glue is wet and the frame is clamped, carefully clean up any excess glue from around the frame. The masking tape applied earlier will help with this, once done the masking tape can be removed.

Once the glue is applied and the frame is in place, leave to dry for at **least 24 hours**.

VW T3 Vanagon Emuwing Installation Instructions

Due to the intrusion of the hinge this product is not suitable for vehicles with passengers in the seats adjacent to the Emuwing. The Emuwing is designed as **an addition** to a storage system and should be removed if the seats adjacent to the Emuwing are ever reinstated. The glue can be cleaned up using wax and grease remover whilst wet, do not leave it to dry or it will be difficult to remove without damage to the paintwork.

Do Not proceed with fitting any hardware to the frame until the glue has set and the frame is securely in place (at least 24 hours). Figure 3.

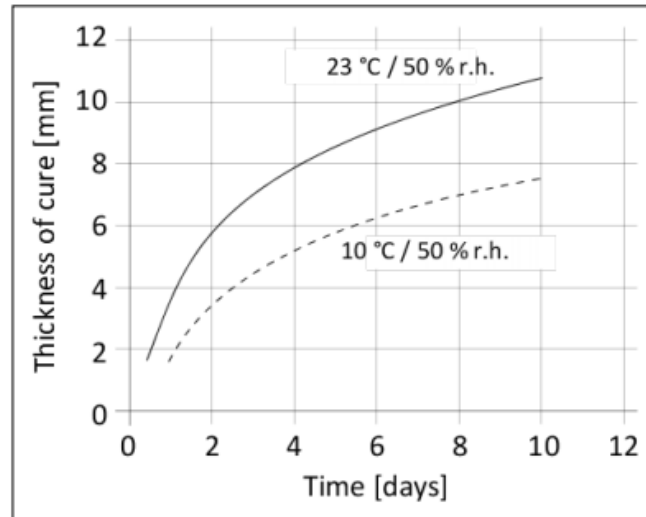

Figure 3.

3: Attaching the door panel.

- Place and tighten the support brackets.
Assemble the support brackets on top of the frame; using the previously removed nuts and washers to clamp the frame to the body over the pinch weld. Do not over tighten these bolts, just tighten them firmly. Figure 5.

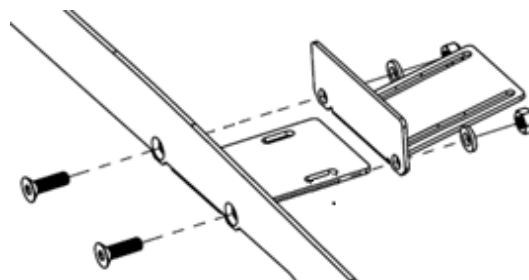
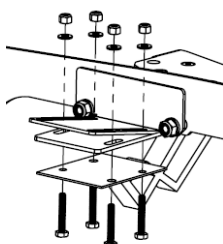

Figure 5.

Ensure the two bolts are evenly tightened so the slots in the two brackets align and the bracket is firmly against the body.

Figure 6.



- Attach the hinges.

Attach the Hinges to the frame using the supplied 4mm nuts, bolts and washers so the face plate protrudes around 10mm from the frame. The exact depth will be adjusted later. Figure 6.

VW T3 Vanagon Emuwing Installation Instructions

Due to the intrusion of the hinge this product is not suitable for vehicles with passengers in the seats adjacent to the Emuwing. The Emuwing is designed as **an addition** to a storage system and should be removed if the seats adjacent to the Emuwing are ever reinstated.

- Applying the weather-strip.

Close the door panel and carefully mark inside the door panel around the inside edge of the frame noting the distance between the line and the edge of your frame.

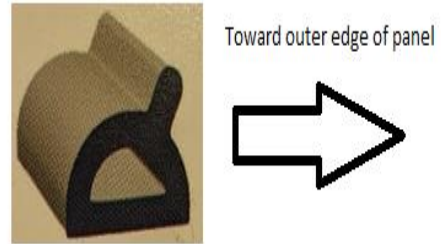

- Primer

Before attaching the weather strip use the 3M primer where you will be applying the weather strip. Apply using long strokes exactly where the weather strip will be placed

Once the door has been marked and primed, the weather seal can be attached to the door following outside of the marked lines so the seal will line up on the frame (if the seal does not correctly align, moisture and dust will find its way into the back of the vehicle).



- Placing the door panel.

When the hinges are in the closed position, place the door panel centrally. We suggest using a spacer at the bottom of the door panel to lift it up slightly so that the panel is aligned correctly.

Figure 9.

Note: when the gas struts are attached the door panel will be pushed up as the hinges compress – try to allow for this when placing the door by positioning the panel 1 or 2 mm lower than it needs to be.

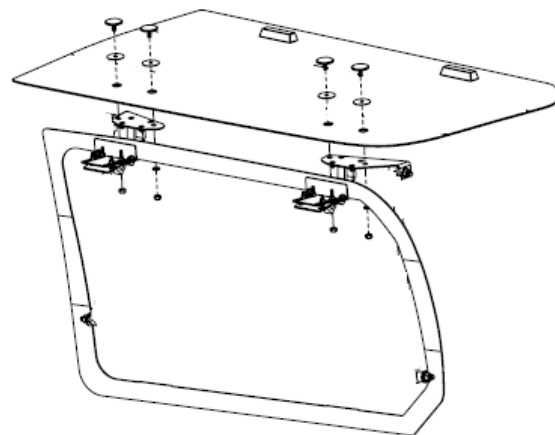

Figure 9.

Close the handles a little so the cam latches over the frame to secure the panel in place while fixing into position.

- Securing the door panel.

Placing the Pan Head bolts from the outside; fit a washer and nut on the inside.

Once all four pan heads are in place and secure, check that the door does not foul the van when opening and closing. If there is any fouling, adjust the door accordingly before attaching the gas struts. Pinch up these bolts before attaching the gas struts.

Before loosening any nuts for any further adjustments, detach the gas struts first to prevent the hinges from twisting.

VW T3 Vanagon Emuwing Installation Instructions

Due to the intrusion of the hinge this product is not suitable for vehicles with passengers in the seats adjacent to the Emuwing. The Emuwing is designed as **an addition** to a storage system and should be removed if the seats adjacent to the Emuwing are ever reinstated.

- Attach the gas struts.

Once the Door panel is adjusted as much as possible open the door and attach the struts (wider end to the top). Close the panel carefully, again watching if it touches the car as it closes. Once closed note any required adjustments to the door panel to align it with the car.

The depth of the door can be adjusted later, at this stage we are only concerned with the position of the panel in relation to the car however if your panel sits out from the frame more than 10mm it may be worth adjusting this in to at least 10mm.

4: Adjusting the door panel depth.

- Adjustments – left/right and up and down.

The door panel can be adjusted up/down and left/right by loosening the pan heads that attach the door to the hinge. Make note of the required adjustments and mark the current position of the hinge plate on the inside of the door before removing the struts and loosening the pan heads.

- Adjustments – Depth.

Close the door panel and check the depth to ensure it aligns with the car and compresses the weather seal. If adjustment is required loosen the hinges from the top supports (the gas struts do not need to be removed), apply pressure evenly to the outside of the door where the hinge meets the door until you see the rubber compress onto the frame, and then re-tighten the bolts.

You may also need to bend the cams on the door locks to compress the bottom part of the weather seal. To do this remove the cam by taking the screw out from the back of the door handle. Put the cam into a vice so that any bend is applied away from the square hole – do not distort or bend this part of the cam. Bend slightly and then retest until the rubber on the panel compresses equally top and bottom.

- Thread locking compound – handle/cam screws.

*The small screw holding the handle and cam in place has not had thread locking compound applied to facilitate any bending required. **It is essential this is applied onto these screws.***

Close the Emuwing ensuring the seal has not rolled and remains attached squarely to the frame, ensure the handles are closed and there is even pressure on the seal all the way around. Now use a heat gun to heat the frame from the back (inside the car) – this will activate the glue on the weather strip and affix it in place permanently. Use a piece of cardboard to protect any trims/roof lining from the heat of the gun as you work your way around and be careful not to burn the seal directly. The frame should be heated to the point that it is very hot to the touch – above 50 degrees Celsius.

Leave the panel closed for an hour or two whilst the glue cools.

If additional help is required, please feel free to give us a call on +613 8592 1926 between the hours of 10am and 4pm AEST – Monday to Friday.

VW T3 Vanagon Emuwing Installation Instructions

Due to the intrusion of the hinge this product is not suitable for vehicles with passengers in the seats adjacent to the Emuwing. The Emuwing is designed as **an addition** to a storage system and should be removed if the seats adjacent to the Emuwing are ever reinstated.

5: Glass supplement.



We recommend tinting the glass prior to installation, this ensures the weather strip will not deteriorate faster than usual due to UV exposure.

Instructions:

1. Ensure glass is tinted and dry before attempting assembly.
2. Disassemble handles noting the order of reassembly, the panel is located between the two rubbers when reassembling.
3. Tighten the barrel nut until the rubbers are compressed ensuring a good seal.
4. Assemble and insert handles.
5. Ensure thread locking compound is used on the 10mm bolt securing the cam latch.

Prior to installation of the Emuwing kit the handles should be reassembled into the glass panel.

Ensure thread locking compound is used on the threads of the 10mm bolt securing the Cam.

Website: emuwing.com.au

Phone: +61 3 9017 1614

Email: info@emuwing.com.au



For Distributor and Installer enquiries please email sales@emuwing.com.au

9/146 Northbourne Road
Campbellfield
Victoria, 3061

ABN: 84 617 251 733